

SCHNEID

Radio-Frequency data transfer using Plug-in card module CM08-RF

Heating center

- boiler visualization
- MSR visualization
- Customer visualization
- QM reports
- Overview of services

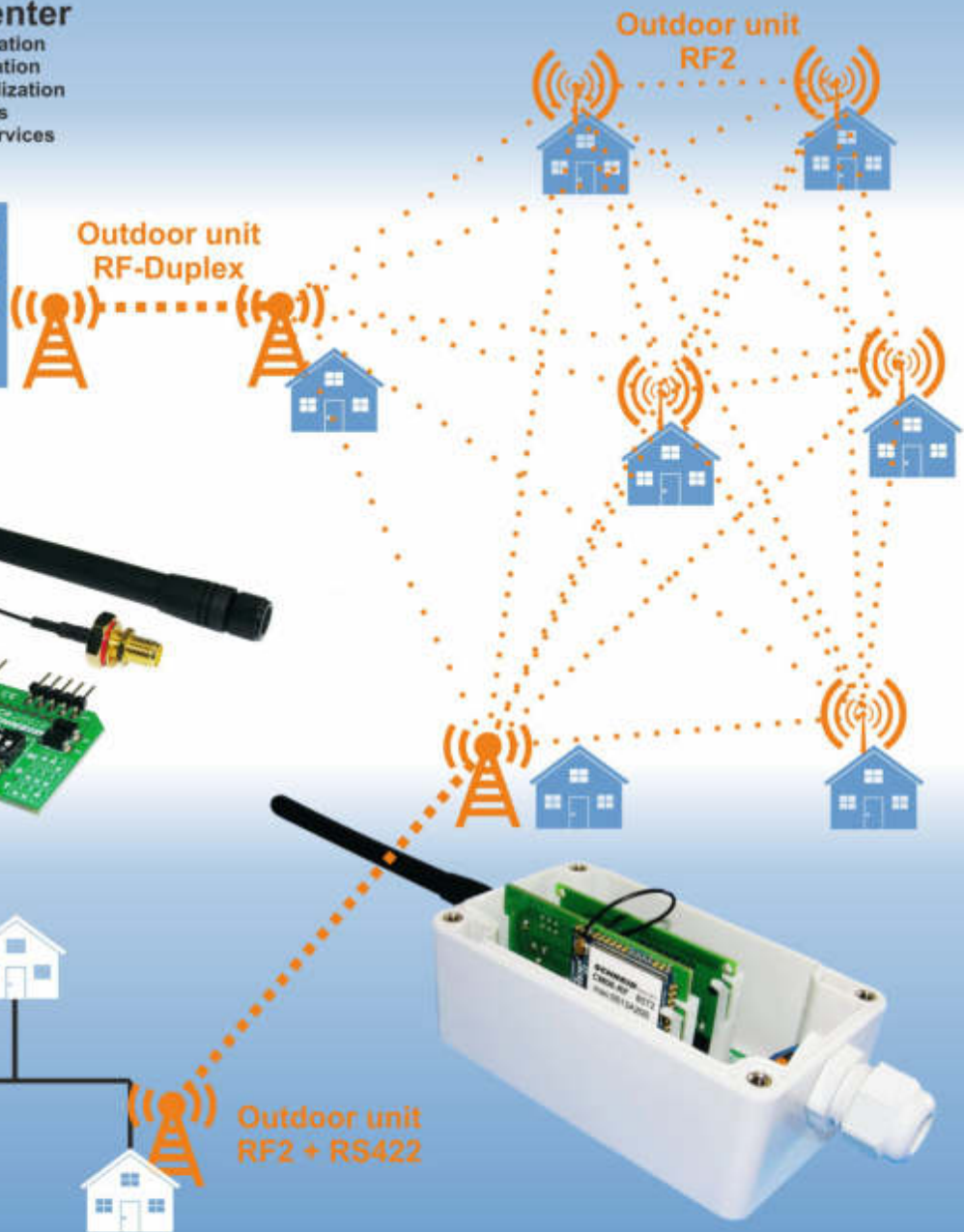

Technical description

Modern Life - Modern Solutions

© 2020 **SCHNEID** GesmbH

All rights reserved. This document is provided by SCHNEID GesmbH.

SCHNEID GesmbH reserves the right to revise and change this document at any time without being obliged to announce or report the changes made.

*SCHNEID GesmbH does not guarantee the accuracy and correctness of the information.
SCHNEID GesmbH assumes no liability or responsibility for errors or omissions in the content of the documentation.
All information in the documentation is given without any express, implied or tacit guarantee.*

Plug-in card modules CM08-RF

SCHNEID plug-in card modules CM08-RFx for radio transmissions

with integrated RS485; for SCHNEID communication base modules

Order number:	130.xxxxx
Order code:	Steckkartenmodul CM08-RFx

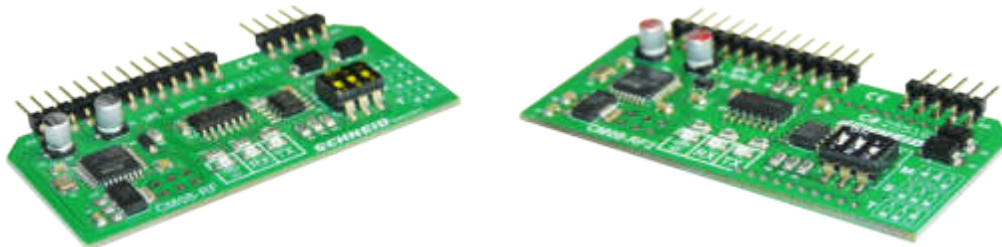

Overview:

The SCHNEID plug-in card module CM08-RFx is only suitable for the SCHNEID communication basic modules of the module control series.

With this module card, the controller can transmit data using radio technology.

Function description:

RF radio module (CM08-RFx)

This module card uses radio technology with a mesh function for data transmission. Each module in a network is connected to one or more others. The information is forwarded from one module to another until it has reached its destination. The modules act as routers and clients at the same time. With this technology, long ranges can be achieved on the one hand and the network is self-healing and therefore very reliable. If a connection is blocked or has failed, the data is automatically redirected and the network is still operational. In addition to 128-bit AES encryption, different preambles or network IDs can also be used to set up independent subnets, which do not influence each other.

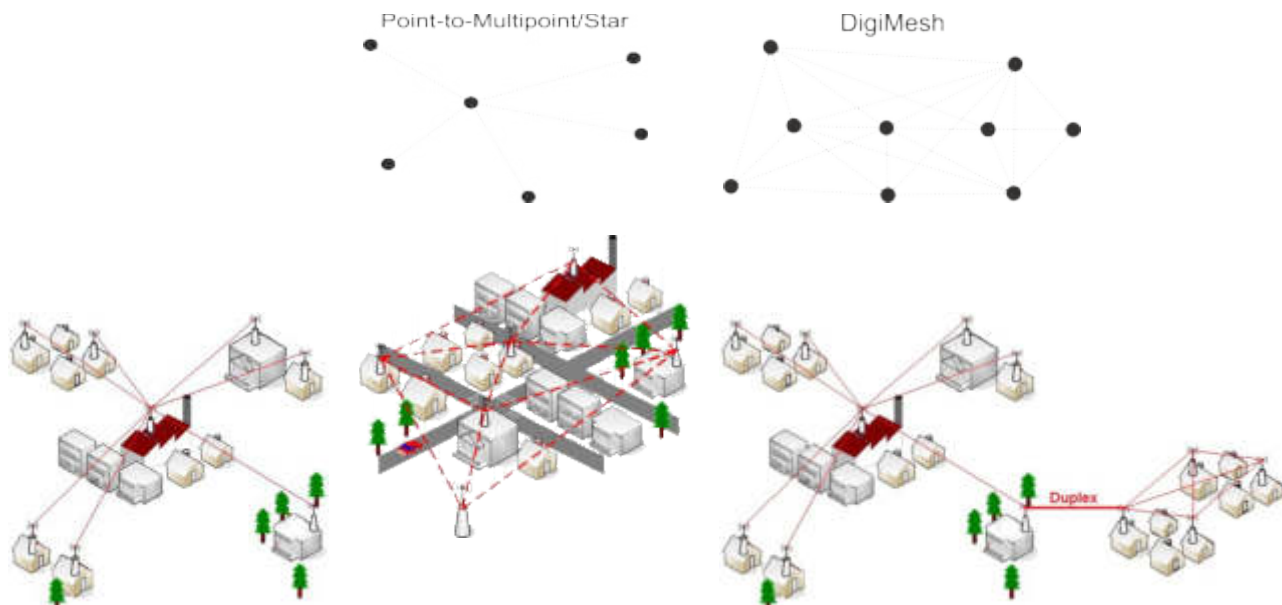

Plug-in card modules CM08-RF

Variants:

SCHNEID plug-in card module CM08-RF1 for radio transmissions

Order number: 130.15948

Order code: Steckkartenmodul CM08-RF1

For use in sub-communications with RS485 and radio.

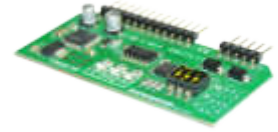

SCHNEID plug-in card module CM08-RF1 with screw antenna

Order number: 130.15949

Order code: Steckkartenmodul CM08-RF1 Schraubantenne

For use in sub-communications with RS485 and radio.



SCHNEID plug-in card module CM08RF2 for radio transmissions

Order number: 130.15914

Order code: Steckkartenmodul CM08-RF2

For connecting the outdoor unit and controller.



SCHNEID plug-in card module CM08RF2 with screw antenna

Order number: 130.15915

Order code: Steckkartenmodul CM08-RF2 Schraubantenne

For connecting the outdoor unit and controller.



Antennas and adapter cables:

SCHNEID antenna for radio module standard

Order number: 020.14266

Order code: Antenne für Funkmodul Standard



SCHNEID antenna adapter cable 80mm for BT, RF (radio) and GPRS

Order number: 020.14254

Order code: Antennen-Adapterkabel 80



SCHNEID antenna adapter cable 250mm for BT, RF (radio) and GPRS

Order number : 020.14255

Order code: Antennen-Adapterkabel 250



SCHNEID antenna adapter cable 500mm for BT, RF (radio) and GPRS

Order number: 020.16196

Order code: Antennen-Adapterkabel 500



Special equipment:

SCHNEID antenna for radio module 868MHz 8dBi

Order number: 020.16463

Order code: Antenne für Funkmodul 868MHz 8dBi

Antenna for radio module 868MHz 8dBi, vert. 17 °,
Ant. Gain up to 8dBi, including adapter type N / SMA St / St.



Plug-in card modules CM08-RF

Repeater module radio:

SCHNEID repeater module radio with 422

Order number: 020.15921

Order code: Repeatermodul Funk mit 422

SCHNEID repeater module radio with 485

Order number: 020.15922

Order code: Repeatermodul Funk mit 485

SCHNEID repeater module radio duplex with 2 x CM08-RF2

Order number: 020.14543

Order code: Repeatermodul Funk Duplex mit 2 x RF2



Serviceadapter Funk:

SCHNEID Serviceadapter FUNK zur Kommunikation mit allen SCHNEID-Modulreglern

Order number: 020.15976

Order code: Serviceadapter Funk für alle Reglerversionen

The service adapter is used to scan and configure a radio network.



Installation:

Assembly:

The module card can be installed directly in the COM base board of a controller. However, the antenna must not be more than 30 cm away and must be installed outside the controller housing.

Since in most cases the control device is installed in the basement, it is necessary to mount the transmitter unit on the outside of the building. The outdoor unit COM-RF-LP-AE485 is available for this application. This outdoor unit consists of a weatherproof housing with antenna, a CM09-R base board and an RS485 interface card for connection to the control unit. This outdoor unit is connected to the control unit via a 4-pin cable connection (2 wires for bus, 2 wires for power supply 12VDC). An RS422 interface card can be used instead of the RS485 for the integration of older control devices. The cabling must then be 6-pin.

The possible cabling options for using the RF module are shown on the following pages.

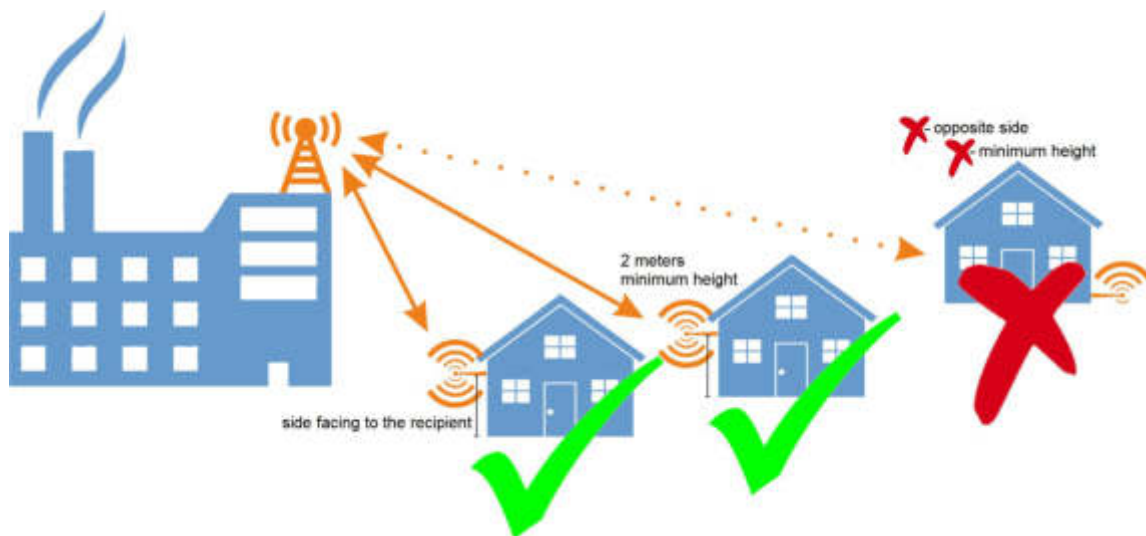

Visual vs. Line-of-Sight:

The presence of an RF Line-of-Sight (LOS) between the transmitting and receiving antennas is essential to achieve a long range in wireless communication systems.

There are two types of LOS that are typically used to describe an environment:

-> Visual LOS is the ability to see from one location to another.

It only requires a straight linear path between two points.

-> RF LOS requires not only visual LOS, but also a football-shaped path free of obstacles in order to optimally send data from one point to another. This is also called the Fresnel zone



To achieve the greatest range, the Fresnel zone in which the radio waves travel must be free of obstacles. Buildings, trees or other obstacles in the way reduce the communication area.

If the antennas are barely mounted on the ground, half of the Fresnel zone is obstructed by the earth, which leads to a significant reduction in the area. To avoid this problem, the antennas should be mounted high enough from the ground so that the earth does not disturb the central diameter of the Fresnel zone.

It is also important to understand that the environment can change over time due to growing vegetation, building construction, etc.

If there are obstacles between two points, the antennas can be raised at one end or at both ends to remove the obstacles from the Fresnel zone.

The diameter of the Fresnel zone determines how far above the ground and other obstacles the antennas must be. The diameter of the Fresnel zone depends on the frequency and the distances between the two transmitters.

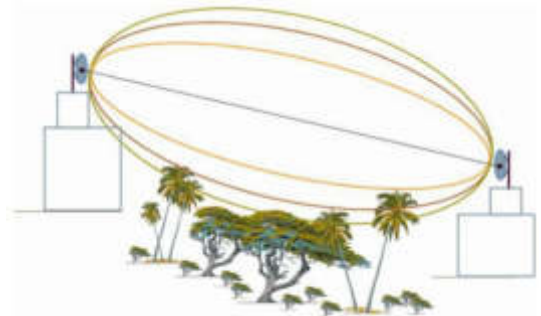

Various data points have been inserted into Fresnel zone formulas to provide some reference points. The following table provides approximate Fresnel zone diameters at 300m, 1.6km, 8km and 16km.

In order to have ground clearance, the combined antenna height should be equal to the diameter of the Fresnel zone.

Range Distance	Required Fresnel Zone Diameter (900 MHz Radios)	Required Fresnel Zone Diameter (2.4 GHz Radios)
1000 ft. (300 m)	16 ft. (7 m)	11 ft. (5.4 m)
1 Mile (1.6 km)	32 ft. (12 m)	21 ft. (8.4 m)
5 Miles (8 km)	68 ft. (23 m)	43 ft. (15.2 m)
10 Miles (16 km)	95 ft. (31 m)	59 ft. (20.2 m)

Plug-in card modules CM08-RF

Terminal plan RF module on COM board

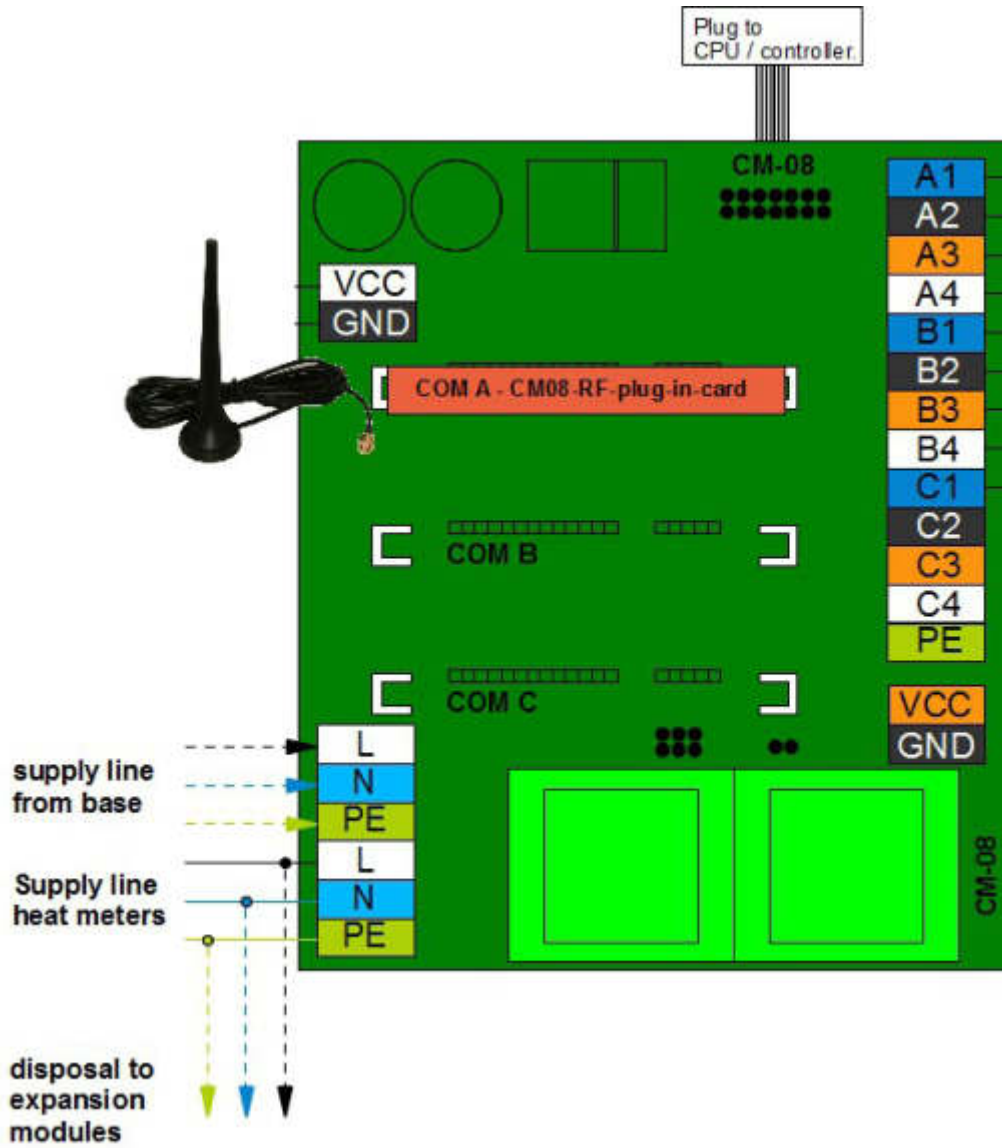

Plug-in card modules CM08-RF

Terminal plan RF module with outdoor unit via RS485 connection

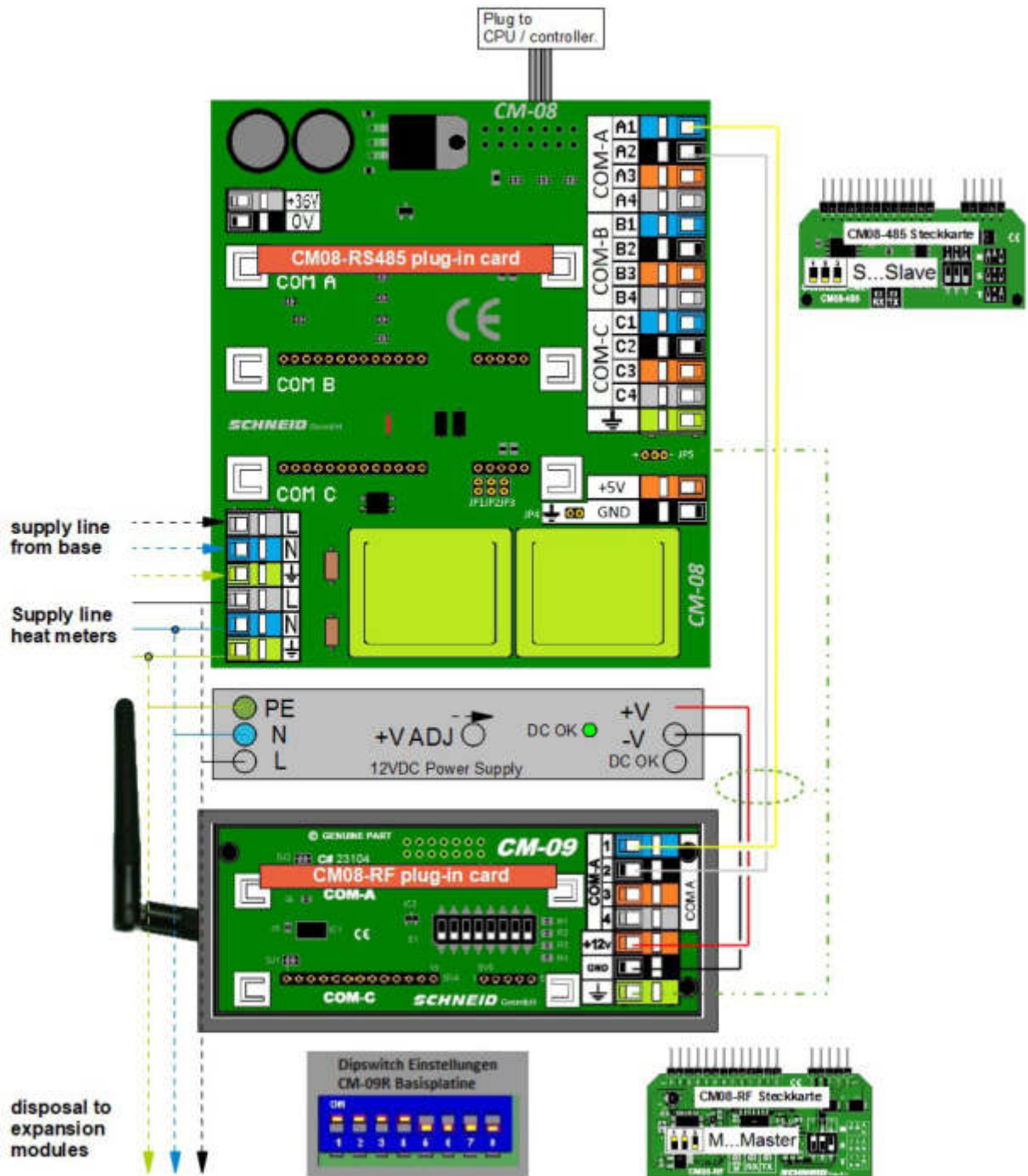

Plug-in card modules CM08-RF

Terminal plan RF module with outdoor unit via RS422 connection

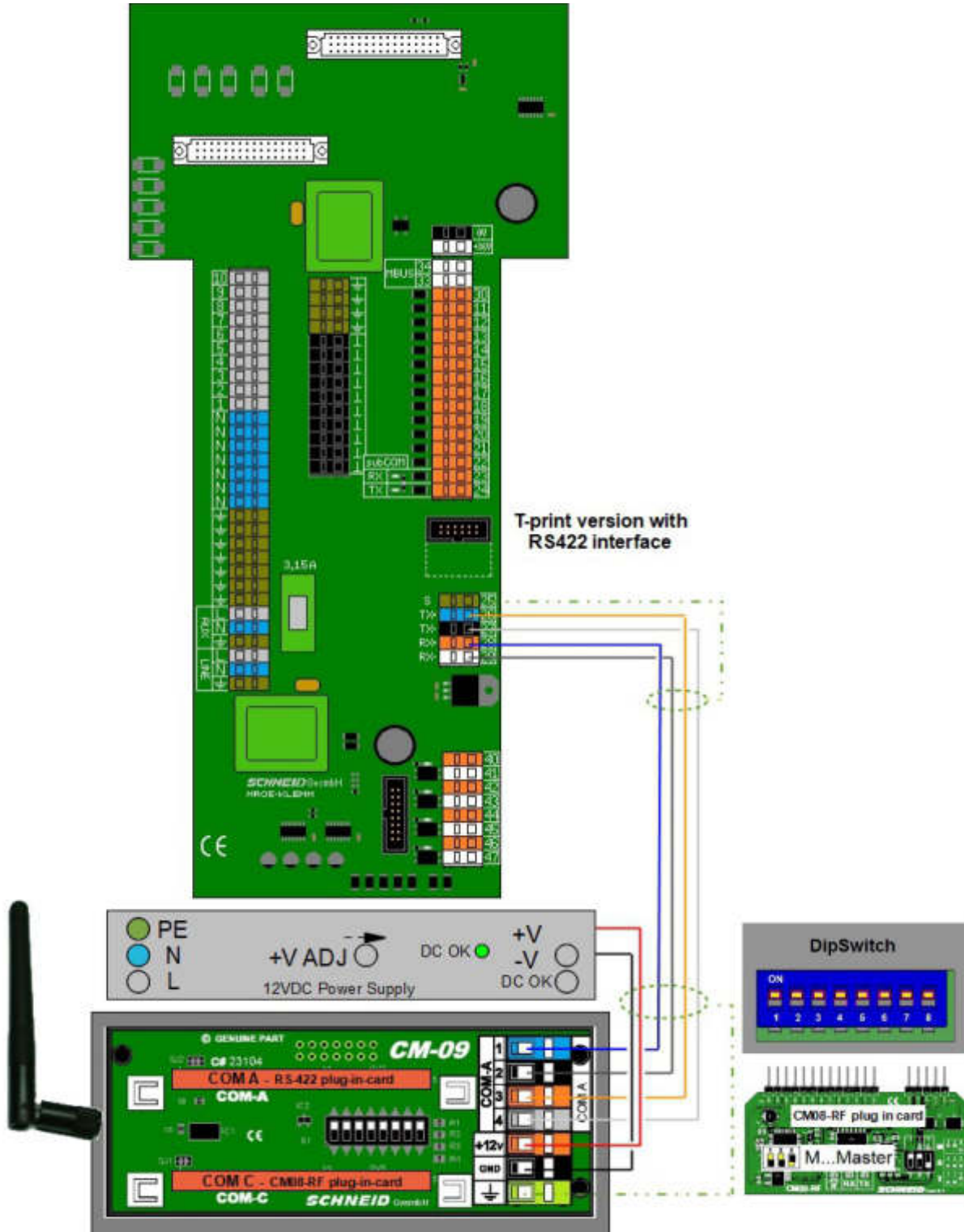

Plug-in card modules CM08-RF

Terminal plan RF module with sub-communication to other controllers

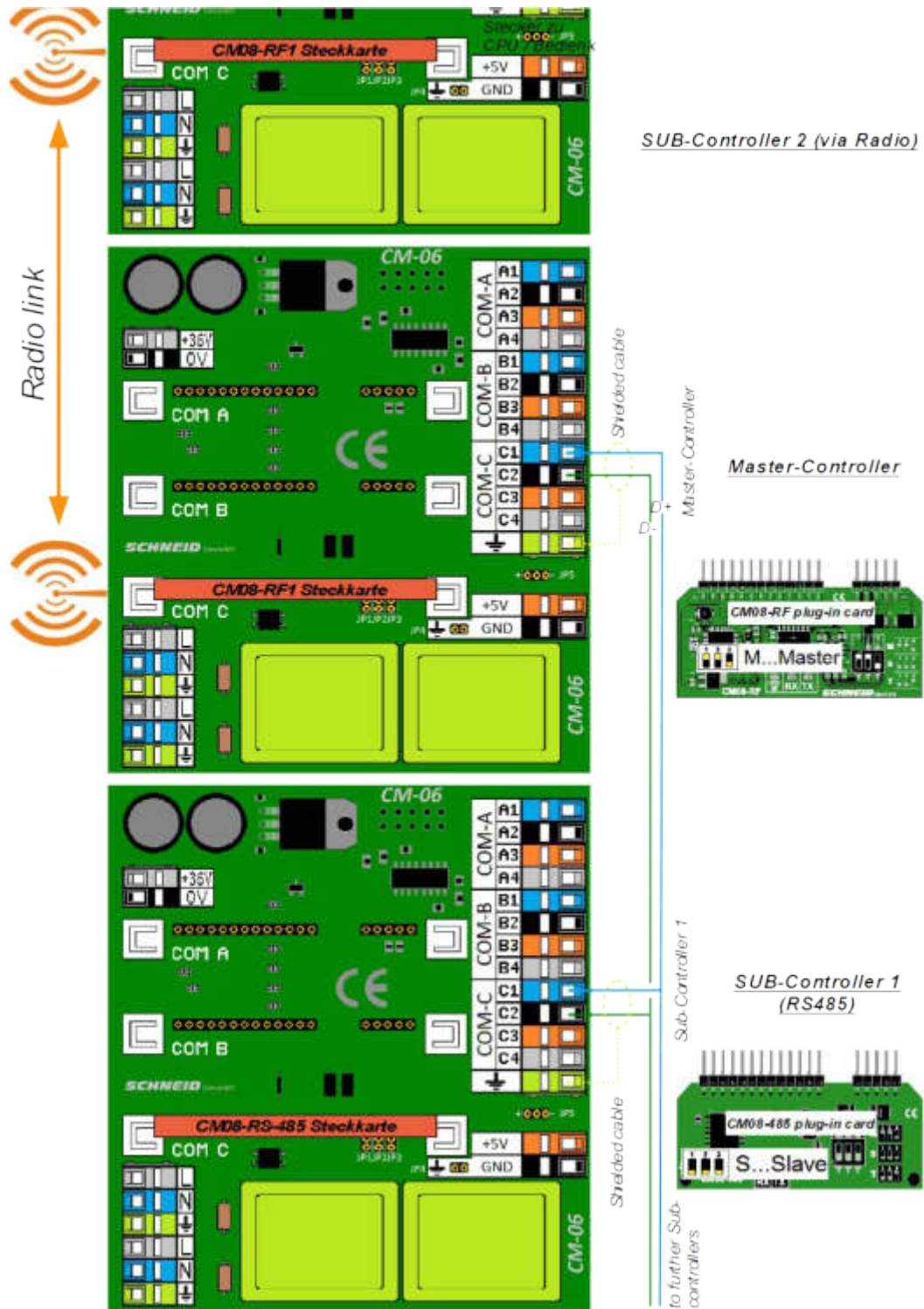

Plug-in card modules CM08-RF

Scope of delivery SCHNEID plug-in card module CM08-RF:

- V1: SCHNEID plug-in card module CM08-RF1 for radio transmission with adapter cable
- V2: SCHNEID plug-in card module CM08-RF1 for radio transmission with adapter cable and screw antenna
- V3: SCHNEID plug-in card module CM08-RF2 for radio transmission with adapter cable
- V4: SCHNEID plug-in card module CM08-RF2 for radio transmission with adapter cable and screw antenna

Technical data SCHNEID plug-in card module CM08-RF:

Intrastat Number:	8537.10.91.90
Country of origin	EU/AT
Height, width, depth (in mm)	38x65x10 (plug-in card module Rfx) 80x10x10 (adapter cable) 130x10x10 (antenna)
Weight (in kg)	0.004 (adapter 80mm) 0.017 (plug-in card module Rfx + adapter) 0.030 (plug-in card module Rfx + adapter and antenna)
Degree of protection	IP-00
Ambient temperature	0°C....+40°C
Operating voltage	5VDC
Power consumption	75mA
Max baud rate	115200 Bit/s
Connection type	Pin headers for base module
Mounting type	Plug-in card module
Operating time	Continuous operation
Degree of pollution	2
RF connection type	u.FL Connector
Frequency range	863 - 870 MHz
Transmit power	up to 13 dBm ERP
Range	up to 1000m free field of vision
Temperature range	-40°C to +85°C
Encryption	128-bit AES
RF data rate	80Kbps
Receiver sensitivity	-106 dBm @ 80Kbps; -113dBm @ 10 Kbps
Network topologies	DigiMesh, Repeater, Point-to-multipoint, Peer-to-peer maximum 128 node

Technical data SCHNEID antenna for plug-in card module CM08-RFx:

Screw antenna 868 MHz:

Intrastat Number:	8529.10.69
Country of origin	EU/AT
Height, width, depth (in mm)	130x10x10
Weight (in kg)	0,0130
Degree of protection	IP-20
Operating temperatur	-10°C~+75°C
Storage temperature	-30°C~+75°C
Antenna cover	TPU
Antenna base	PC
Connection coating	black Nickel
Interconnects	RP-SMA
Frequency range	868 MHz
Impedance	50 Ohm
VSWR	< 2.0
Return loss	-24.213 dB at 868 MHz

Antenna for radio module 868MHz 8dBi:

Intrastat Number:	8529.10.69
Country of origin	EU/AT
Height, width, depth (in mm)	1474x26x26
Weight (in kg)	0,8700
Degree of protection	IP-65
Operating temperatur	-40°C~+60°C
Storage temperature	-40°C~+60°C
Housing material	GFK UV geschützt
Frequency range	860-870 MHz
Impedance	50 Ω
Transmit power	max. 100 W
Mounting type	Mast; Wand

Scope of delivery SCHNEID repeater module radio xxx:

SCHNEID repeater module radio with 422

Scope of delivery:

SCHNEID plastic housing for repeater CM09-R (400.14253)
 SCHNEID communication base module CM09-R (130.14548)
 SCHNEID plug-in card module CM08-RF2 (130.15914)
 SCHNEID plug-in card module CM08-422 (130.13975)
 SCHNEID antenna for plug-in card module CM08-RFx (020.14266)
 SCHNEID antenna adapter cable 80 (020.14254)

SCHNEID repeater module radio with 485

Scope of delivery:

SCHNEID plastic housing for repeater CM09-R (400.14253)
 SCHNEID communication base module CM09-R (130.14548)
 SCHNEID plug-in card module CM08-RF2 (130.15914)
 SCHNEID antenna for plug-in card module CM08-RFx (020.14266)
 SCHNEID antenna adapter cable 80 (020.14254)

Technical data SCHNEID repeater module radio with 422/485:

Intrastat Number:	8537.10.91.90
Country of origin	EU/AT
Height, width, depth (in mm)	270x65x56 (Repeatermodul Funk mit 422) 270x65x56 (Repeatermodul Funk mit 485)
Weight (in kg)	0,204 (Repeatermodul Funk mit 422) 0,196 (Repeatermodul Funk mit 485)
Degree of protection	IP-20
Operating temperatur	-25°C~+55°C
Storage temperature	-25°C~+55°C
Mounting type	Wandmontage
Operating time	Dauerbetrieb
Degree of pollution	2
Frequency range	868 MHz
Impedance	50 Ohm

Plug-in card modules CM08-RF

Scope of delivery SCHNEID repeater module radio duplex with 2 x CM08-RF2:

SCHNEID repeater module radio duplex with 2 x CM08-RF2

Scope of delivery:

SCHNEID plastic housing for repeater CM10-R (400.15274)
SCHNEID communication base module CM10-R (130.15260)
2 x SCHNEID plug-in card module CM08-RF2 (130.15914)
2 x SCHNEID antenna for plug-in card module CM08-RFx (020.14266)
2 x SCHNEID antenna adapter cable 80 (020.14254)

Technical data SCHNEID repeater module radio duplex:

Intrastat Number:	8537.10.91.90
Country of origin	EU/AT
Height, width, depth (in mm)	270x90x56
Weight (in kg)	0,290
Degree of protection	IP-20
Operating temperatur	-25°C~+55°C
Storage temperature	-25°C~+55°C
Mounting type	Wandmontage
Operating time	Dauerbetrieb
Degree of pollution	2
Frequency range	868 MHz
Impedance	50 Ohm

Plug-in card modules CM08-RF

Scope of delivery SCHNEID radio service adapter for all controller versions:

SCHNEID radio service adapter for all controller versions

Scope of delivery:

SCHNEID service adapter RADIO

SCHNEID antenna for plug-in card module CM08-RFx

Micro USB cable.

Technical data SCHNEID radio service adapter for all controller versions:

Intrastat Number:	8537.10.91.90
Country of origin	EU/AT
Height, width, depth (in mm)	VPE 180x110x15
Weight (in kg)	0,112
Degree of protection	IP-65
Ambient temperature	0°C....+40°C
Connection type	Micro-USB-Anschluss
Mounting type	Adapter
Degree of pollution	2

Our services in summary

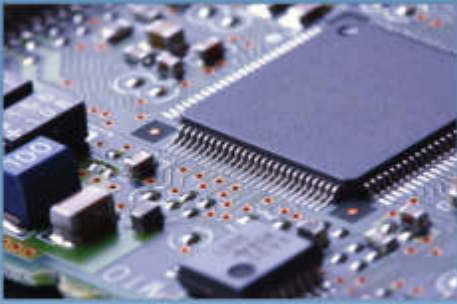

Hardware

Development at first hand



Project management

Supervise and achieve your goals



Software

Solve custom demands and requirements



Monitoring system

The entire system at a glance



Quality management

Safeguards a first-class quality



Support

Your concern is our request



All rights reserved. This document is provided by the SCHNEID GesmbH.

© 2020 **SCHNEID** GesmbH
Gewerbering 14-16
8054 Graz/Pirka, Austria
Phone: +43 (0) 316 28 50 22 - 0
Fax: +43 (0) 316 28 50 22 - 21
www.schneid.at